

# REYNOARCH<sup>®</sup>

ALUMINIUM COMPOSITE LOUVERS



REDEFINING EXTERIORS

Introducing ReynoArch: The revolutionary, efficient and convenient solution to your home's privacy problems. The preferred choice of builders, architects and other professionals in the industry. ReynoArch's broad selection of designs and continuous innovation ensures that, all your needs are fulfilled. It is also what makes us the leading producer of high Pressure Laminate (HPL) and Aluminium Composite Panel (ACP) in India. Now, we're making it even easier to create your vision of architecture come to life.

The exclusive line of Louvers (Exterior and Interior Cladding Solutions) for high-end constructions. The Louvers we offer have been created to be stunning, and are ideal for those who wish to enjoy the ambience of architectural beauty. The perfect fit for your style, this collection can be the ideal solution to give a personal touch and add a touch of elegance to your office or your home.

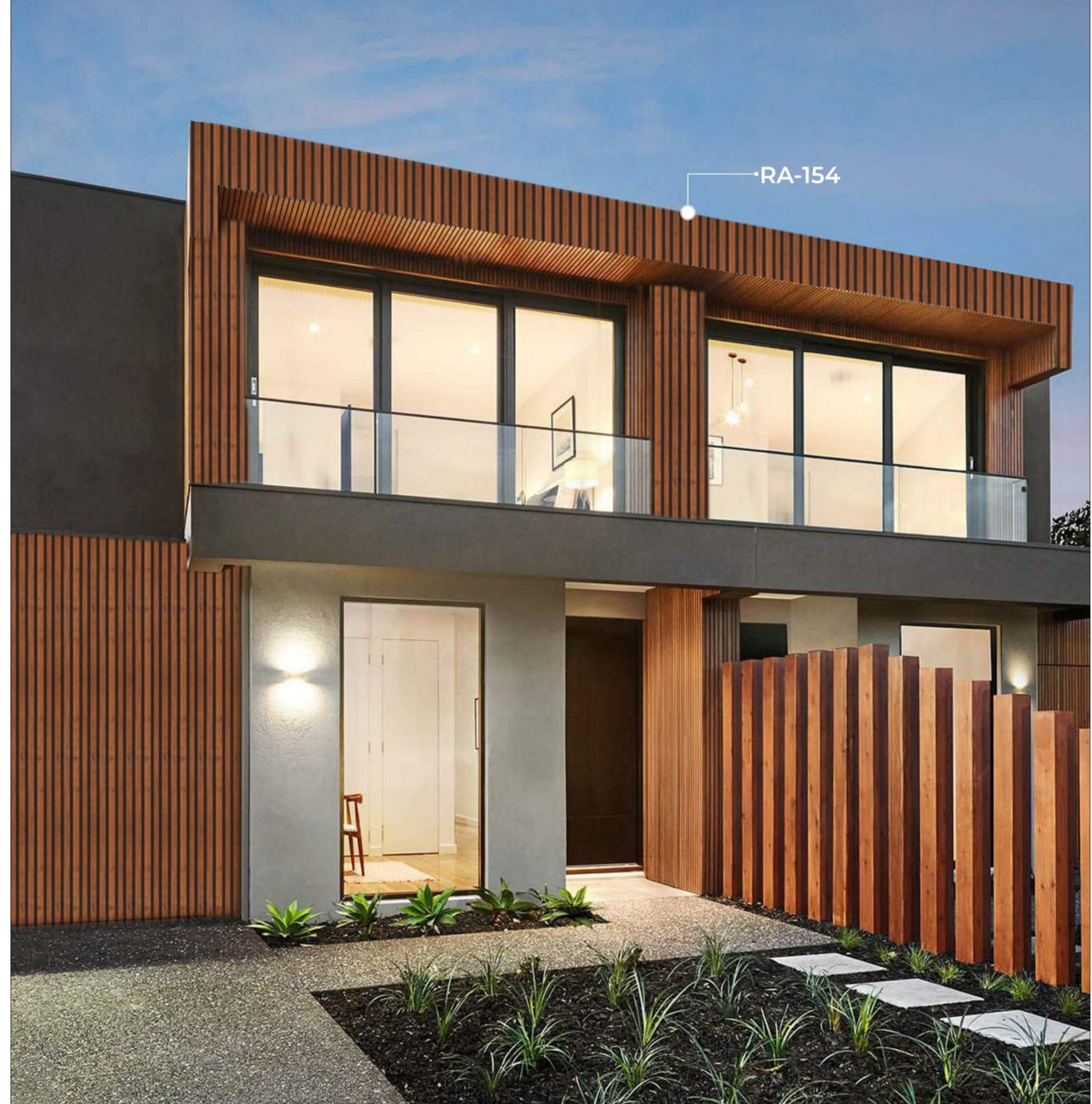



RA-129 TIGER WOOD



RA-154 NOVACENTOPINE



RA-118 DARK TEAK

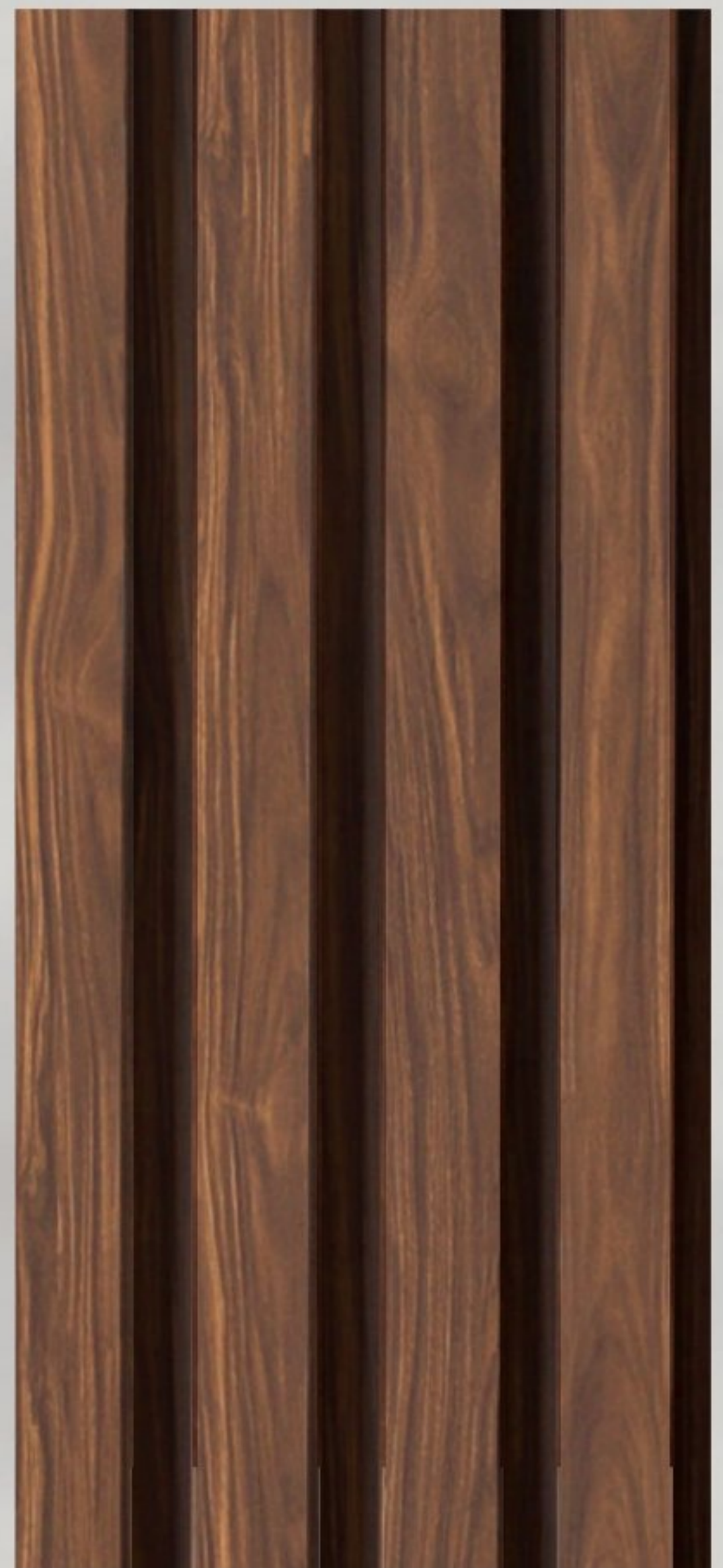

REDEFINING EXTERIORS

RA-116





RA-116 ROYAL TEAK



RA-151 NYANA TEAK



RA-155 SHADOW GREY

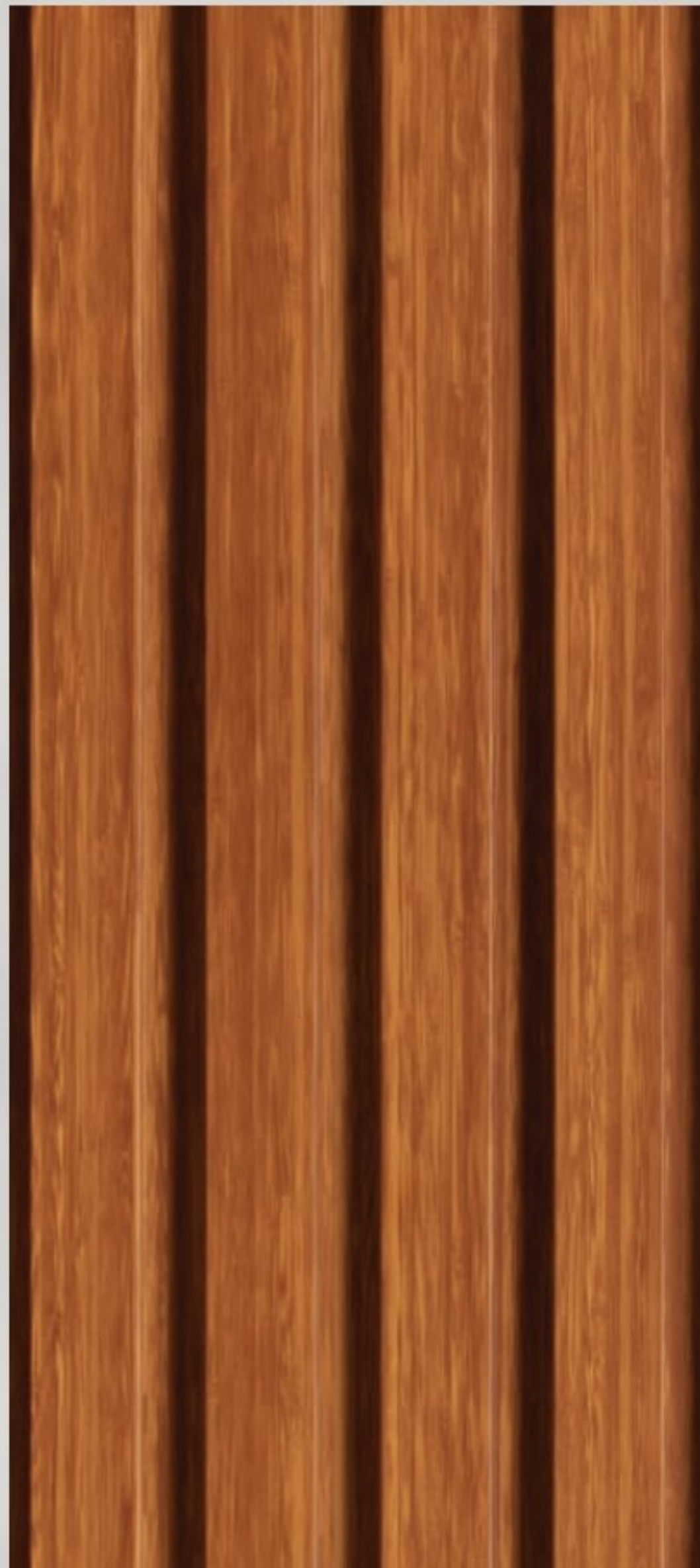

REDEFINING EXTERIORS

RA-147





RA-134 TEAK GOLD



RA-147 DARK OAK



RA-138 SPOT RUSTIC GREY

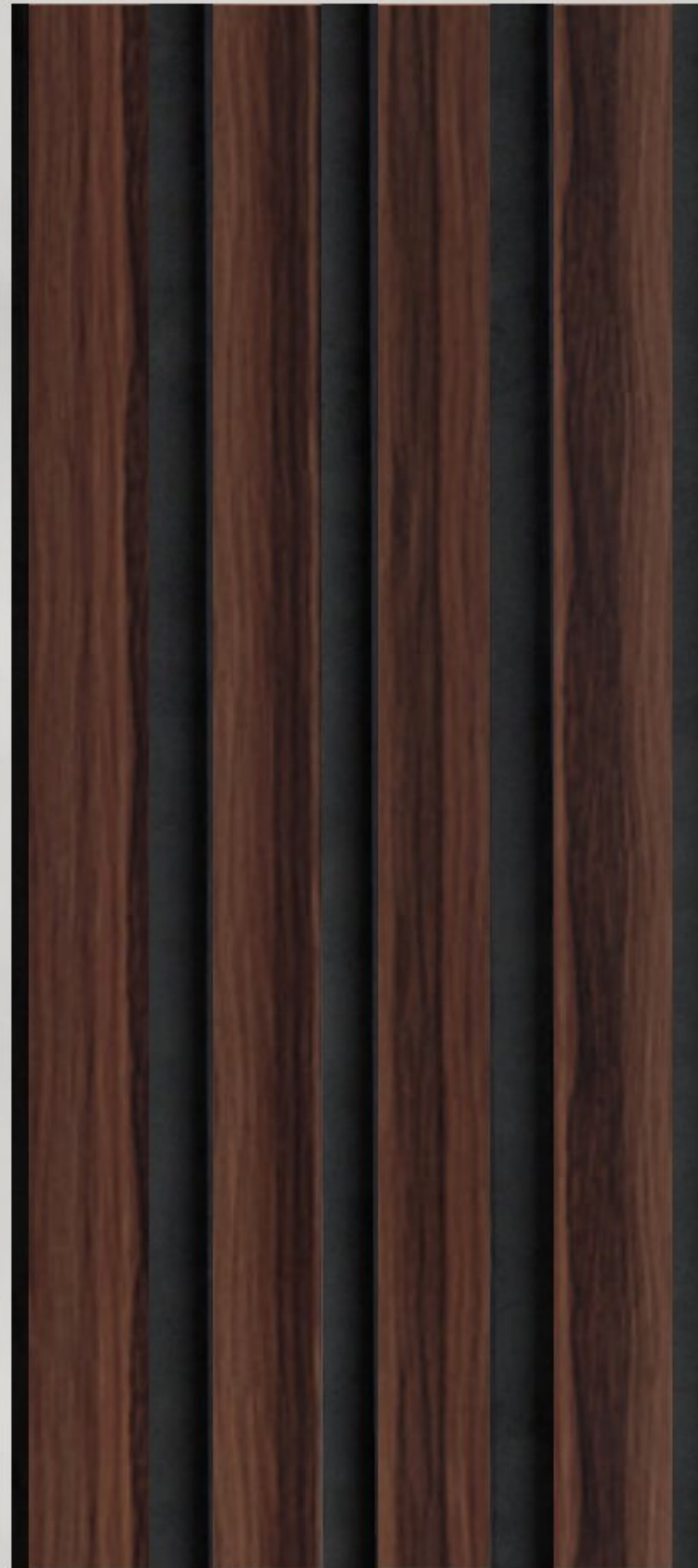

REDEFINING EXTERIORS

RA-31







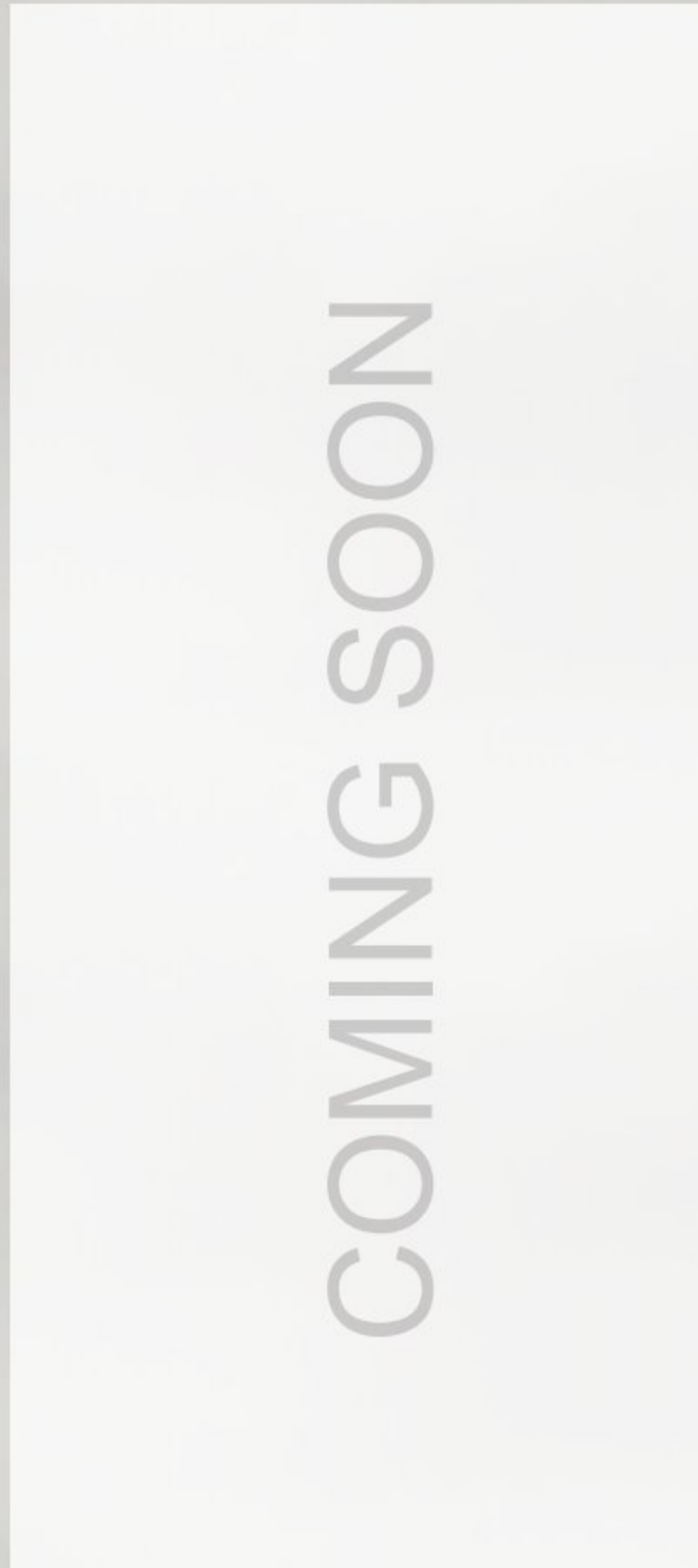
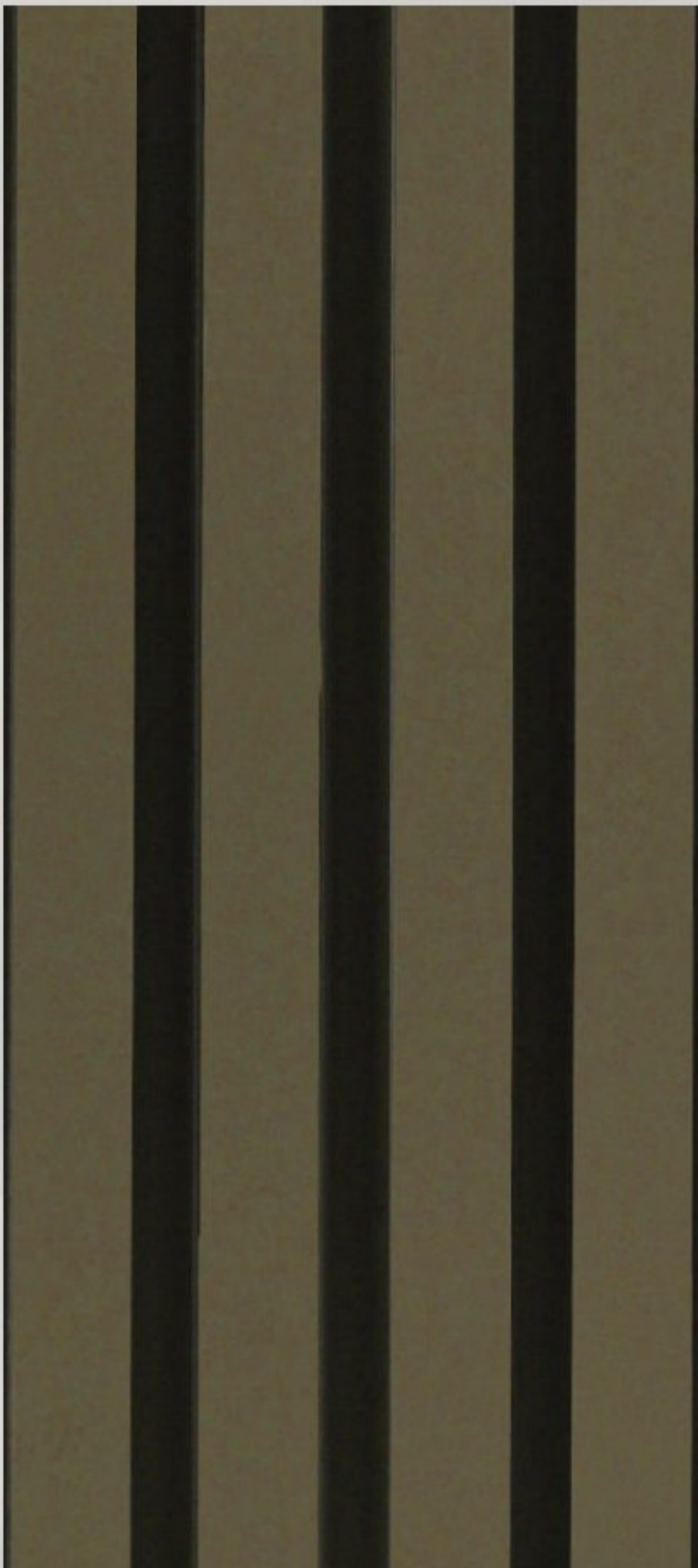



RA-31 COFFEE SILVER



REDEFINING EXTERIORS

**WHY REYNOARCH**<sup>®</sup>  
ALUMINIUM COMPOSITE **LOUVERS**

-  EASY INSTALLATION
-  READY TO USE
-  WATER & TERMITE PROOF
-  100% MAINTENANCE FREE
-  WIDE RANGE OF COLOURS
-  IDEAL FOR RESIDENTIAL & COMMERCIAL BUILDINGS

## APPLICATIONS

- EXTERIOR CLADDING
- INTERIOR - HIGHLIGHTER, PANELS
- BALCONY CLADDING
- ROOF CLADDING
- CANOPY
- GATE PANELING
- FENCE & RAILING

### SERIES: 3000

610MM(W) X 2440MM(H)  
PANEL THICKNESS: 30MM  
TOLERANCE: ±10MM

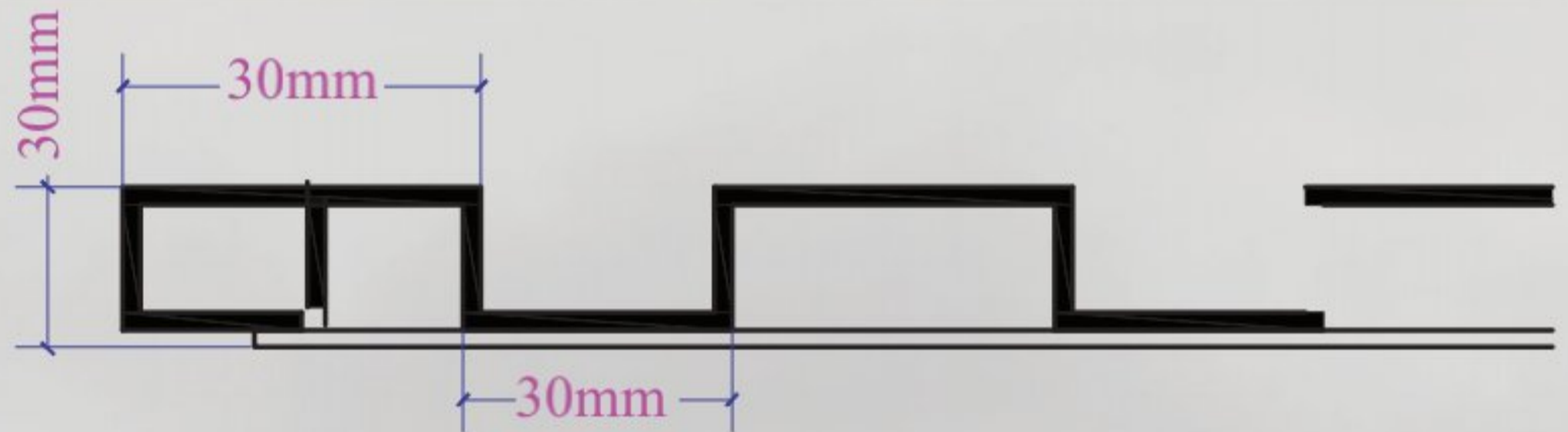

### SERIES: 5000

762MM(W) X 2440MM(H),  
PANEL THICKNESS: 30MM  
TOLERANCE: ±10MM

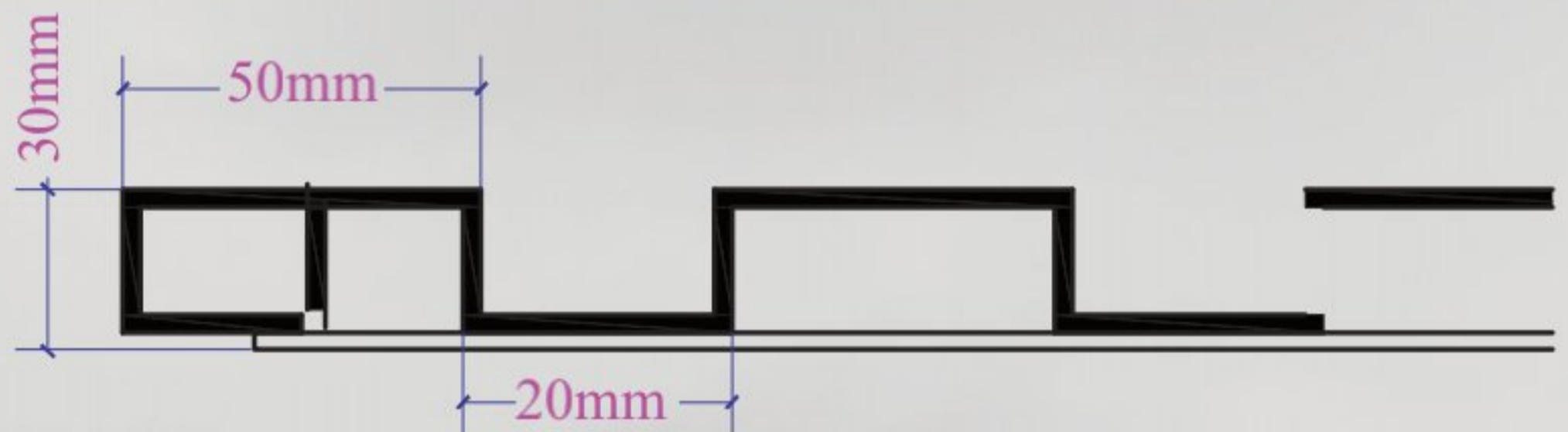

\*CUSTOMISED LENGTH IS ALSO AVAILABLE (UP TO 3660MM).

\*\*ACTUAL COLOURS MAY VARY FROM THE PICTURES SHOWN IN THE BROCHURE.

\*\*\*OTHER SHADES AVAILABLE ON DEMAND

REDEFINING EXTERIORS

# REYNOARCH<sup>®</sup>

ALUMINIUM COMPOSITE **LOUVERS**

# 12

years  
warranty

## REYNOBOND INDIA

HEAD OFFICE

2E/7, Jhandewalan Extension,  
New Delhi - 110055

Tel : 011-42307700 | +91-9810846953

E: info@reynobondindia.com

Branch Offices:

Bangalore • Bhubaneswar • Chennai • Delhi • Hyderabad  
Indore • Kochi • Kolkata • Lucknow • Noida • Patna • Pune  
Ranchi.



Channel Partner



COMPOSITE PANELS | WOOD POLYMER COMPOSITE | SILICONE SEALANTS | CHEMICALS

# OUR PRODUCTS

**ALSTONE**<sup>®</sup>  
SILICONE SEALANT

**ALSTONE**<sup>®</sup>  
STIXALL

**ALSTONE**<sup>®</sup>  
HYBRID BOARD (WPC)

**ALSTONE**<sup>®</sup>  
WPC DOOR FRAME

**ALSTONE**<sup>®</sup>  
1.25MM PVC LAMINATE

**ALSTONE**<sup>®</sup>  
WPC DOOR

**ALSTONE**<sup>®</sup>  
WPC SHUTTERING PLY

**ALSTONE**<sup>®</sup>  
SILICONE OIL

**ALSTONE**<sup>®</sup>  
CHEMICALS

**ALSTONE**<sup>®</sup>  
WPC **LOUVERS**

**ALSTONE**<sup>®</sup>  
STIXLAM

**REYNOARCH**<sup>®</sup>  
ALUMINIUM COMPOSITE PANEL

**REYNOARCH**<sup>®</sup>  
HIGH PRESSURE LAMINATE

**REYNOARCH**<sup>®</sup>  
HONEYCOMB PANEL

**REYNOARCH**<sup>®</sup>  
DECORATIVE GLASS

**REYNOARCH**<sup>®</sup>  
ALUMINIUM COMPOSITE **LOUVERS**

**FACADE**<sup>®</sup>  
ALUMINIUM COMPOSITE PANEL

**FACADE**<sup>®</sup>  
HIGH PRESSURE LAMINATE

REDEFINING EXTERIORS